

# NEON EDGE

RGBW | SILICONE

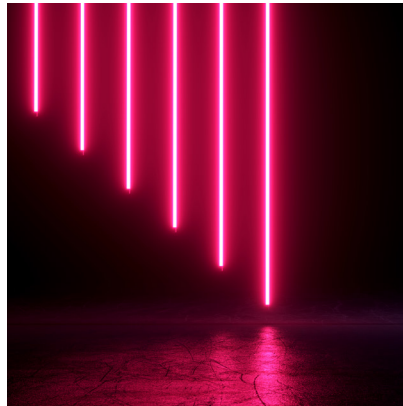

## APPLICATIONS

- Creative colour installations. Soften colours to pastels.
- Theatres, bars, restaurants, and retail
- Cove lighting, handrails, or toekicks
- Architectural features
- Exterior or interior installations
- Swimming or feature pools

## FEATURES

- UV & flame resistant

Neon is a broad range of silicone encapsulated LED ribbons with a variety of light emissions and casings that closely reference glass neon tube.

Neon Edge is a sleek W11.5 x H21mm model.

RGB White (Red, Green, Blue, and White) ribbon provides a rainbow of colour options. The white can be used independently of the colours or in combination creating of soft pastel effects.

Neon is made to order, check with our team for lead times.

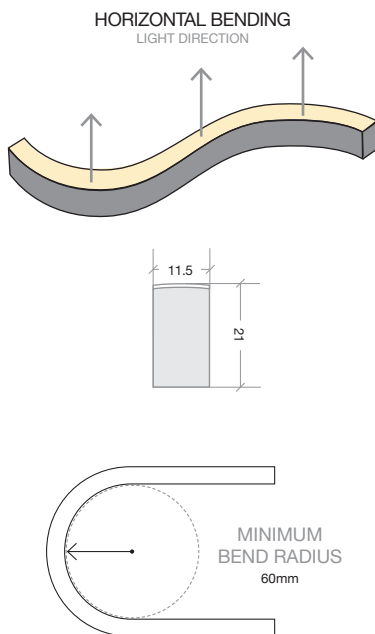

CODE	COLOUR	LUMENS
BL-LS-4150S-RGBW	R 615–625nm	≥50lm/m
	G 520–530nm	≥120lm/m
	B 465–475nm	≥25lm/m
	W 3000K +/- 220K	≥120lm/m

ELECTRICAL & OPTICAL DATA VARIANCE +/- 10%. SOLD BY THE METRE. IES FILES AVAILABLE. 2700K & 4000K AVAILABLE BY REQUEST.

POWER & TEMP		PHYSICAL PARAMETERS & CONTROL	
LED WATTS	15W/m	MINIMUM BEND RADIUS	60mm
INPUT VOLTS	24V DC Constant voltage	BEND DIRECTION	Horizontal bending
OPERATING TEMP. (ENVIRONMENT)	-40°C ~ +45°C	DIMENSIONS	W11.5 x H21mm
MAX. RUN PER POWER FEED	<b>Static full loading*</b> 8m using one feed 16m using two feeds <b>Dynamic operating*</b> 12m using one feed 24m using two feeds	INGRESS PROTECTION	IP68 Slimline Injection moulding connections <i>Dimensions of connectors shown on installation guide</i>
CUTTING LENGTH			100mm
<b>LIGHT &amp; LIFE</b>		HOUSING	UV & flame resistant white silicone with opal diffuser
CRI	≥80 (white chip only)	MOUNTING	Profile / clips available SEE PAGE 3.
BEAM ANGLE	160°	CONTROL	Requires 4-channel RGB controller or compatible DMX-512 controller & decoder
LED PER METRE	60		
SOURCE LIFE	50,000 hours		
WARRANTY	5 years		

## \*STATIC VS DYNAMIC OPERATING

This product has a maximum wattage of 15W/m, made from 4 x colour channels using approximately 3.75W/m each. The white chip can be used on its own or combined with the R, G, B for extra brightness/lumen output. As this uses the full 15W/m this is called Static loading (all colour channels, all powered).

When R, G, B or W channels are used individually or blended to make colour mixes eg blue or purple, the wattage used is below the maximum load and is considered dynamic operating. This also applies when the colours are constantly changing, flashing or fading.

When the maximum wattage of the product is reached, lengths longer than recommended may experience power loss, reduced luminosity & increased heat which can shorten the life of the product.

If unsure about the products intended usage, future proof by choosing the static full loading lengths.

## NEON EDGE | RGBW | CONNECTIONS

Neon products are IP rated based on the fitted connections (power feed / end caps).

Bright Light recommend using Slimline injection moulding for the best result, a clean finish and IP68 rating. These are fitted at factory during the production process and can not be altered once produced - **ensure all lengths are double-checked before ordering.**

Power feed connectors are priced & supplied with 1metre cable as standard. Please specific at time of quoting if alternate lengths are required.

## SLIMLINE INJECTION MOULDING CONNECTIONS | IP68



REQUIRES FITTING AT FACTORY.  
EXACT LENGTH REQUIRED BEFORE PRODUCTION



SIDE FEED



BOTTOM FEED



TOP END FEED



END CAP



300MM FLEXIBLE  
CONNECTOR



T FEED

NEON EDGE | MOUNTING ACCESSORIES

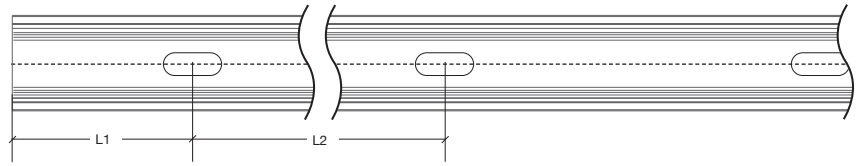

CODE	ACCESSORY	L1	L2	HOLE DIMENSIONS	HOLE NUMBER
BL-LS-4082	SERRATED ALUMINIUM CLIP 20MM	10mm	-	4 × 10mm	1
BL-LS-4080	SERRATED ALUMINIUM PROFILE 1 METRE	100mm	200mm	4 × 10mm	5
BL-LS-4081	SERRATED ALUMINIUM PROFILE 2 METRES	100mm	200mm	4 × 10mm	10
BL-LS-4083	BENDABLE SERRATED ALUMINIUM PROFILE 1000MM	116.5mm	98.8mm	Ø4.2mm	10
BL-LS-4084	THICKENED PLASTIC CLIP 35MM	17.5mm	-	4.5 × 8mm	1
BL-LS-4085	THICKENED PLASTIC PROFILE 1 METRE	100mm	200mm	4.5 × 8mm	5
BL-LS-4086	THICKENED PLASTIC PROFILE 2 METRE	100mm	200mm	4.5 × 8mm	10

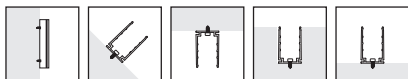
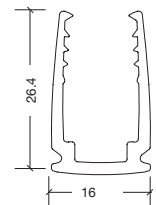
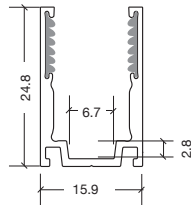
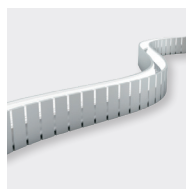
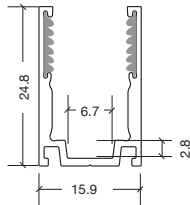

SERRATED ALUMINIUM  
PROFILE 2M & MOUNTING CLIP

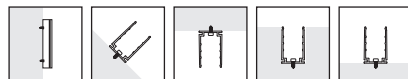

BENDABLE SERRATED  
ALUMINIUM PROFILE 1M

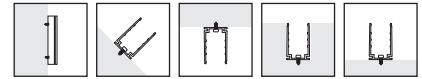

THICKENED PLASTIC  
PROFILE & CLIP